

B55 LVS

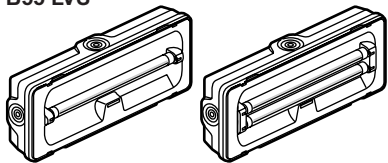

6 624 01/02/03 (NM) 6 624 23/24 (C)

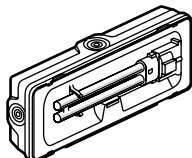

6 624 04/09 (NM)

6 624 01	1h - NM	IP 55 – IK 07		100 lm	L 6W 840 G5
6 624 02	1h - NM	IP 55 – IK 07		170 lm	L 6W 840 G5
6 624 03	1h - NM	IP 55 – IK 07		300 lm	L 6W 840 G5
6 624 04	1h - NM	IP 55 – IK 07		450 lm	PL 11W 840 2G7
6 624 09	2h - NM	IP 55 – IK 07		250 lm	PL 11W 840 2G7
6 624 23	1h - C	IP 55 – IK 07		100 lm	2*L 6W 840 G5
6 624 24	1h - C	IP 55 – IK 07		250 lm	2*L 6W 840 G5

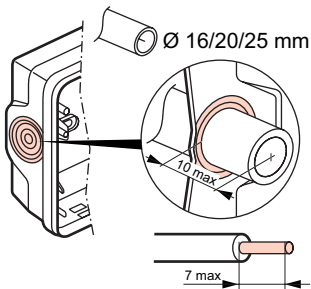
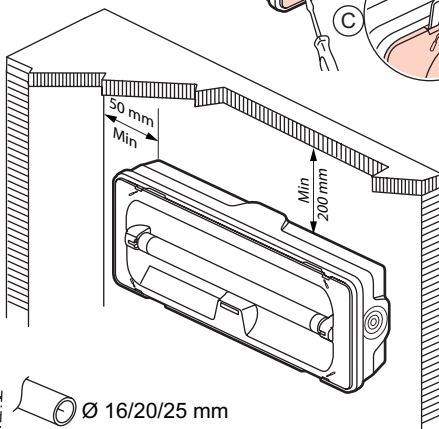
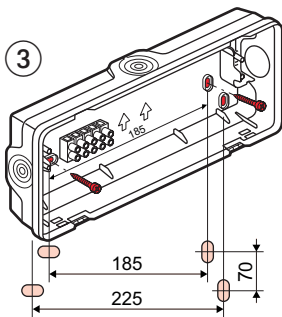
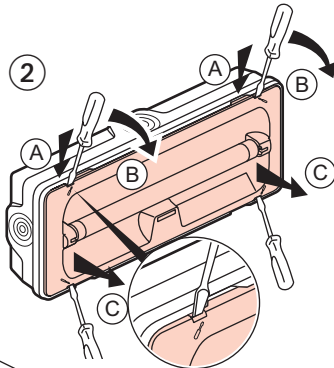
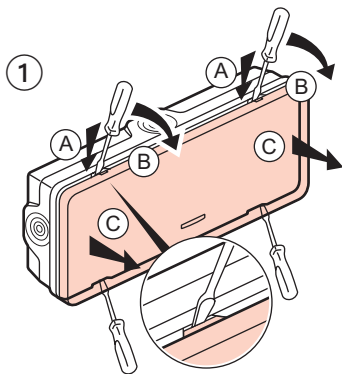

6 624 01/02/03/04/09 (NM)

Ref. 0 626 00

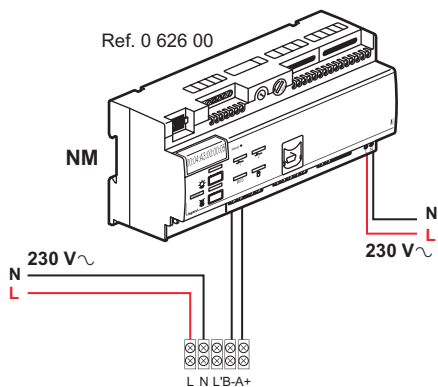

6 624 23/24 (C)

Ref. 0 626 00

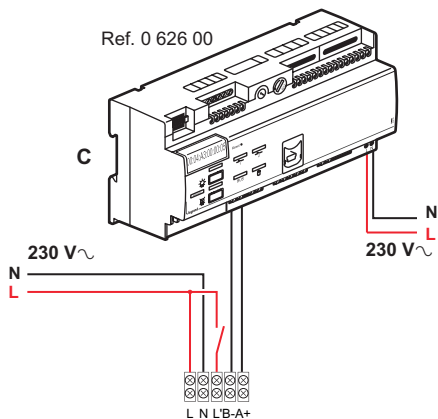

- Ce bloc LVS peut être contrôlé avec l'interface référence 0 626 00. Pour cela il doit être adressé manuellement avec les micro-switches. Voir le «manuel de mise en oeuvre» des blocs Sati adressables.
- This LVS unit can be controlled using interface Cat. No. 0 626 00. To do so, it must be addressed manually, using the micro-switches. See the installation manual for addressable self-testing luminaires.
- Dit LVS-blok kan worden bediend met de interface met referentie 0 626 00. Daartoe moet het worden handmatig geadresseerd met de microswitches. Raadpleeg de «toepassingshandleiding» van de adresseerbare SATI-blokken.
- Este bloco LVS pode ser controlado com a interface de referência 0 626 00. Para isso, ele deverá ser endereçado manualmente com os micro-interruptores. Ver o «manual de instalação» dos blocos endereçáveis com autoteste.
- Diese LVS Notleuchte kann über die Schnittstelle Art. Nr. 0 626 00 angesteuert werden. Dazu muss er manuell über die entsprechenden Mikroschalter adressiert werden. Siehe dazu im «Installationshandbuch» der adressierbaren selbsttestenden Notleuchten.
- Este bloque LVS se puede controlar con la interfaz referencia 0 626 00. Para ello debe direccionarse manualmente con los microinterruptores. Ver el «manual de instalación» de bloques de luminarias autotest direccionables.

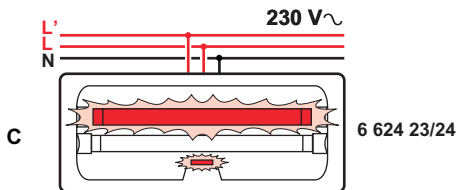
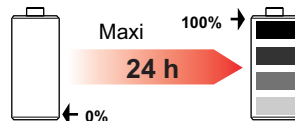
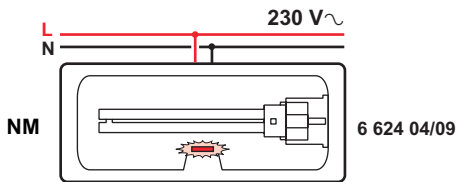
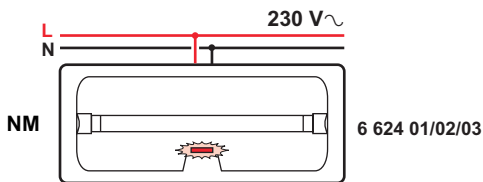

- Test automatique hebdomadaire
- Weekly automatic test
- Wekelijkse automatische test
- Teste semanal automático
- Automatischer Wochentest
- Test automático semanal

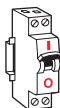

15 s

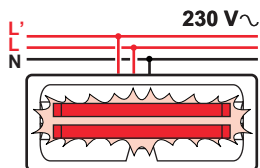
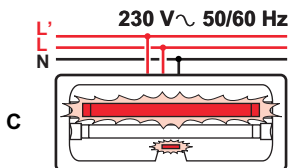
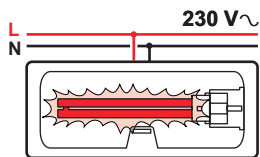
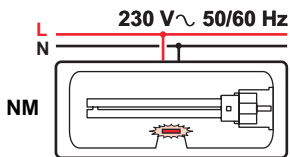
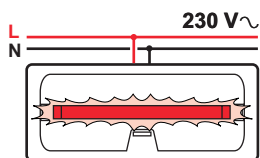
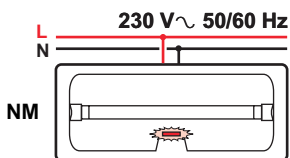

- Voyant fixe vert
- Green indicator steady
- Brandend groen controlelampje
- Indicador verde permanente
- Grünes Dauerlicht
- Piloto verde fijo

OK



- Voyant clignotant jaune
- Yellow indicator flashing
- Knipperend geel controlelampje
- Indicador amarela intermitente
- Gelbes Blinklicht
- Piloto amarillo intermitente

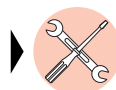

- Test automatique trimestriel
- Quarterly automatic test
- Driemaandelijke automatische test

- Teste trimestral automático
- Automatischer Quartalstest
- Test automático trimestral



1h => Réf. 6 624 01/02/03/04/23/24

2h => Réf. 6 624 09

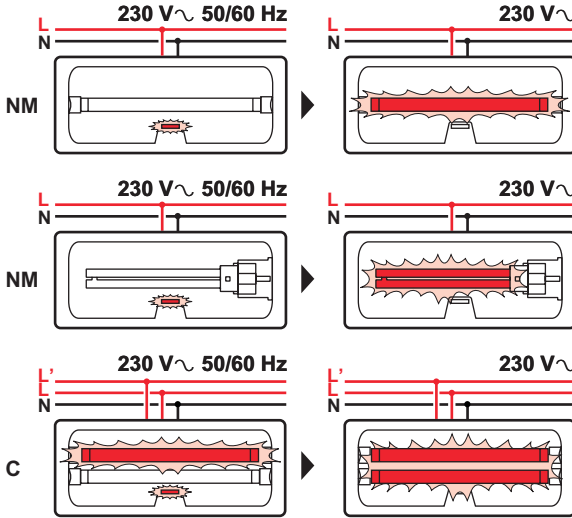

- Voyant fixe vert
- Green indicator steady
- Brandend groen controlelampje
- Indicador verde permanente
- Grünes Dauerlicht
- Piloto verde fijo



- Voyant fixe jaune
- Yellow indicator steady
- Brandend geel controlelampje
- Indicador amarela permanente
- Gelbes Dauerlicht
- Piloto amarillo fijo

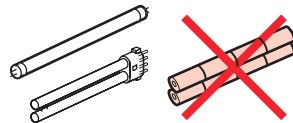
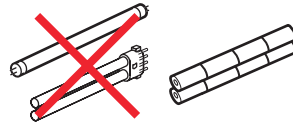
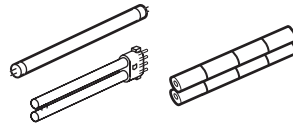
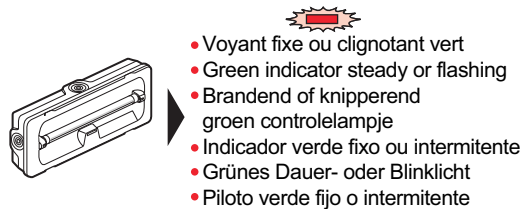
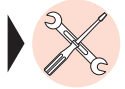

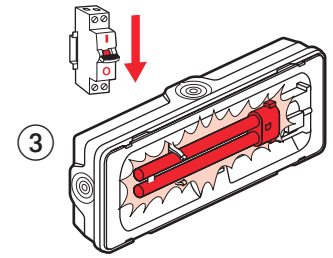
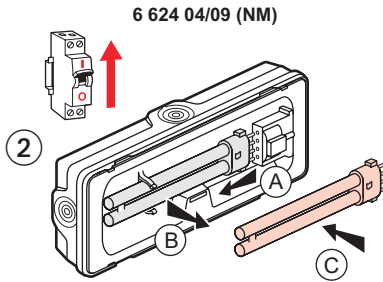
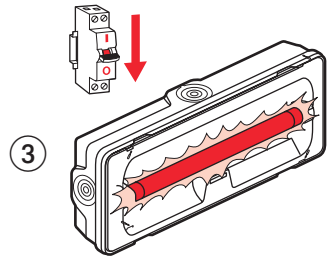
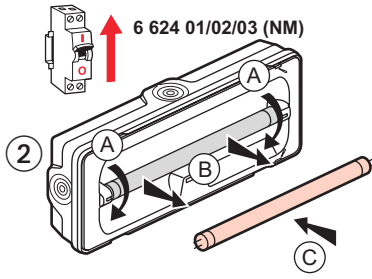
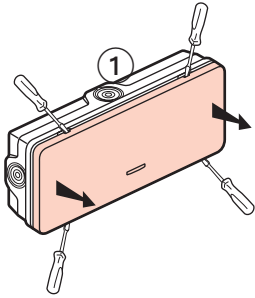
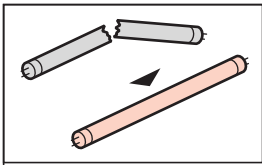

6 624 23/24 (C)

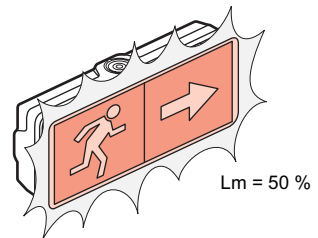
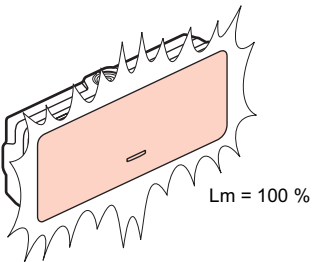
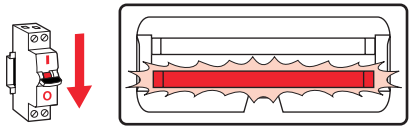
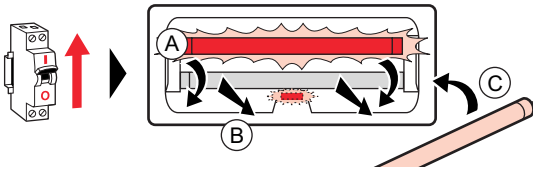
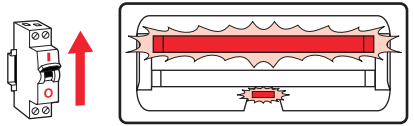
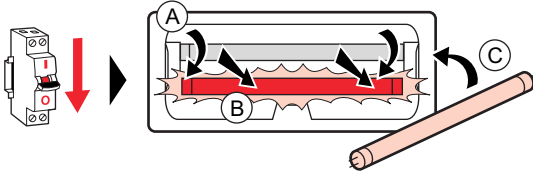

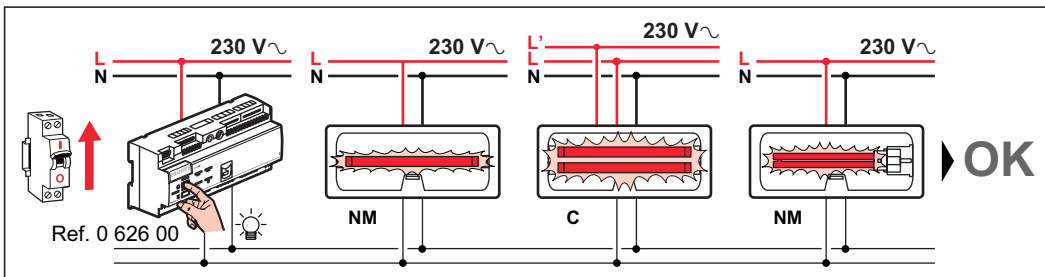
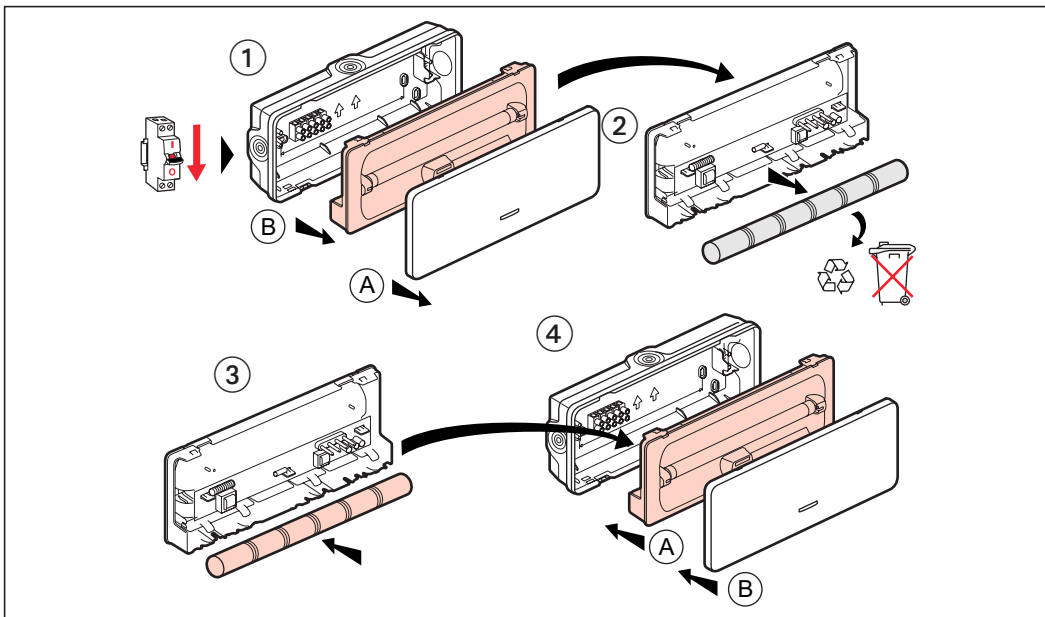

⚠ Consignes de sécurité

Ce produit doit être installé conformément aux règles d'installation et de préférence par un électricien qualifié. Une installation et une utilisation incorrectes peuvent entraîner des risques de choc électrique ou d'incendie. Avant d'effectuer l'installation, lire la notice, tenir compte du lieu de montage spécifique au produit.

Ne pas ouvrir, démonter, altérer ou modifier l'appareil sauf mention particulière indiquée dans la notice. Tous les produits Legrand doivent exclusivement être ouverts et réparés par du personnel formé et habilité par Legrand. Toute ouverture ou réparation non autorisée annule l'intégralité des responsabilités, droits à remplacement et garanties. Utiliser exclusivement les accessoires de la marque Legrand.

(FR LU BE CH)

⚠ Sicherheitshinweise

Dieses Produkt darf nur durch eine Elektro-Fachkraft eingebaut werden. Bei falschem Einbau bzw. Umgang besteht das Risiko eines elektrischen Schlages oder Brandes. Vor der Installation die Anleitung lesen, den produktspezifischen Montageort beachten.

Das Gerät vorbehaltlich besonderer, in der Betriebsanleitung angegebener Hinweise nicht öffnen, zerlegen, beschädigen oder abändern. Alle Produkte von Legrand dürfen ausschließlich von durch Legrand geschultes und anerkanntes Personal geöffnet und repariert werden. Durch unbefugte Öffnung oder Reparatur erlöschen alle Haftungs-, Ersatz- und Gewährleistungsansprüche. Ausschliesslich Zubehör der Marke Legrand benutzen.

(DE)

⚠ Veiligheidsvoorschriften

Dit product moet in overeenstemming met de installatievoorschriften en bij voorkeur door een vakbekwame elektricien worden geïnstalleerd. Bij een onjuiste installatie en een onjuist gebruik bestaat het risico van elektrische schokken of brand.

Lees alvorens de installatie uit te voeren de handleiding door en houd rekening met de specifieke montageplaats van het product. U mag het apparaat niet openen, demonteren of wijzigen, tenzij dat specifiek in de handleiding wordt vermeld. Alle Legrand-producten mogen uitsluitend worden geopend en gerepareerd door personeel dat door Legrand is opgeleid en bevoegd verklaard. In geval van ongeoorloofd openen of repareren wordt geen enkele aansprakelijkheid aanvaard, vervalt het recht op vervanging en zijn de garanties niet meer geldig. Gebruik uitsluitend accessoires van het merk Legrand.

(NL BE)

⚠ Consignas de seguridad

Este producto debe instalarse conforme a las normas de instalación y preferiblemente por un electricista cualificado. Una instalación y una utilización incorrectas pueden entrañar riesgos de choque eléctrico o de incendio. Antes de efectuar la instalación, leer las instrucciones, tener en cuenta el lugar de montaje específico del producto.

No abrir, desmontar, alterar o modificar el aparato salvo que esto se indique específicamente en las instrucciones. Todos los productos Legrand deben ser abiertos y reparados exclusivamente por personal formado y habilitado por Legrand. Cualquier apertura o reparación no autorizada anula la totalidad de las responsabilidades, derechos a sustitución y garantías. Utilizar exclusivamente los accesorios de la marca Legrand.

(ES)

⚠ Safety instructions

This product should be installed in line with installation rules, preferably by a qualified electrician. Incorrect installation and use can lead to risk of electric shock or fire. Before carrying out the installation, read the instructions and take account of the product's specific mounting location.

Do not open up, dismantle, alter or modify the device except where specifically required to do so by the instructions. All Legrand products must be opened and repaired exclusively by personnel trained and approved by Legrand. Any unauthorised opening or repair completely cancels all liabilities and the rights to replacement and guarantees. Use only Legrand brand accessories.

(GB IE)

⚠ Instruções de segurança

Este produto deve ser instalado de acordo com as regras de instalação e de preferência por um electricista qualificado. A instalação e o uso incorrectos podem provocar riscos de choque eléctrico ou de incêndio. Antes de efectuar a instalação, ler as instruções e ter em conta a localização adequada para a montagem do produto.

Não abrir, desmontar, alterar ou modificar o aparelho salvo especificação em contrário nas instruções do produto. Todos os produtos Legrand só devem ser abertos e reparados exclusivamente por pessoal formado e autorizado pela Legrand. Qualquer abertura ou reparação não autorizada cancela todas as responsabilidades, direitos de substituição e garantias. Utilizar exclusivamente os acessórios da marca Legrand.

(PT)